

FEATURES

- Rx mixer with integrated fractional-N PLL**
- RF input frequency range: 1100 MHz to 3200 MHz**
- Internal LO frequency range: 2100 MHz to 2600 MHz**
- Input P1dB: 14.8 dBm**
- Input IP3: 28.5 dBm**
- IIP3 optimization via external pin**
- SSB noise figure**
 - IP3SET pin open: 14.3 dB**
 - IP3SET pin at 3.3 V: 15.6 dB**
- Voltage conversion gain: 6.7 dB**
- Matched 200 Ω IF output impedance**
- IF 3 dB bandwidth: 500 MHz**
- Programmable via 3-wire SPI interface**
- 40-lead, 6 mm × 6 mm LFCSP**

APPLICATIONS

Cellular base stations

GENERAL DESCRIPTION

The ADRF6603 is a high dynamic range active mixer with integrated phase-locked loop (PLL) and voltage controlled oscillator (VCO). The PLL/synthesizer uses a fractional-N PLL to generate a f_{LO} input to the mixer. The reference input can be divided or multiplied and then applied to the PLL phase frequency detector (PFD).

The PLL can support input reference frequencies from 12 MHz to 160 MHz. The PFD output controls a charge pump whose output drives an off-chip loop filter.

The loop filter output is then applied to an integrated VCO. The VCO output at $2 \times f_{LO}$ is applied to an LO divider, as well as to a programmable PLL divider. The programmable PLL divider is controlled by a sigma-delta (Σ - Δ) modulator (SDM). The modulus of the SDM can be programmed from 1 to 2047.

The active mixer converts the single-ended 50 Ω RF input to a 200 Ω differential IF output. The IF output can operate up to 500 MHz.

The ADRF6603 is fabricated using an advanced silicon-germanium BiCMOS process. It is available in a 40-lead, RoHS-compliant, 6 mm × 6 mm LFCSP with an exposed paddle. Performance is specified over the -40°C to $+85^{\circ}\text{C}$ temperature range.

Table 1.

Part No.	Internal LO Range	± 3 dB RF _{IN} Balun Range	± 1 dB RF _{IN} Balun Range
ADRF6601	750 MHz	300 MHz	450 MHz
	1160 MHz	2500 MHz	1600 MHz
ADRF6602	1550 MHz	1000 MHz	1350 MHz
	2150 MHz	3100 MHz	2750 MHz
ADRF6603	2100 MHz	1100 MHz	1450 MHz
	2600 MHz	3200 MHz	2850 MHz
ADRF6604	2500 MHz	1200 MHz	1600 MHz
	2900 MHz	3600 MHz	3200 MHz

FUNCTIONAL BLOCK DIAGRAM

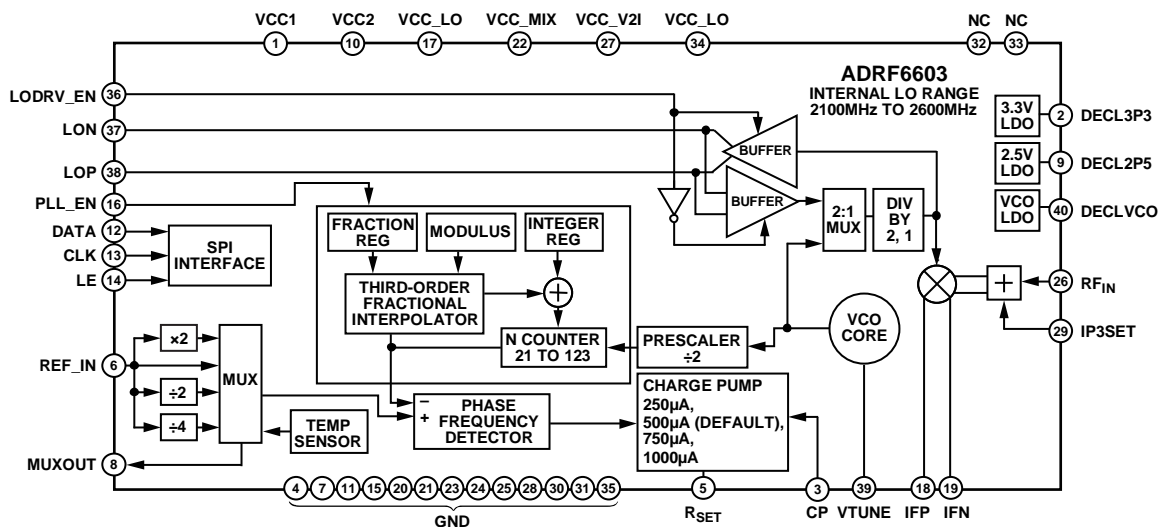

Figure 1.

Rev. A

Information furnished by Analog Devices is believed to be accurate and reliable. However, no responsibility is assumed by Analog Devices for its use, nor for any infringements of patents or other rights of third parties that may result from its use. Specifications subject to change without notice. No license is granted by implication or otherwise under any patent or patent rights of Analog Devices. Trademarks and registered trademarks are the property of their respective owners.

TABLE OF CONTENTS

Features	1	Register 3— Σ - Δ Modulator Dither Control (Default: 0x10000B)	17
Applications	1	Register 4—PLL Charge Pump, PFD, and Reference Path Control (Default: 0x0AA7E4)	18
General Description	1	Register 5—PLL Enable and LO Path Control (Default: 0x0000E5)	19
Functional Block Diagram	1	Register 6—VCO Control and VCO Enable (Default: 0x1E2106)	19
Revision History	2	Register 7—Mixer Bias Enable and External VCO Enable (Default: 0x000007)	19
Specifications	3	Theory of Operation	20
RF Specifications	3	Programming the ADRF6603	20
Synthesizer/PLL Specifications	4	Initialization Sequence	20
Logic Input and Power Specifications	4	LO Selection Logic	21
Timing Characteristics	5	Applications Information	22
Absolute Maximum Ratings	6	Basic Connections for Operation	22
ESD Caution	6	AC Test Fixture	23
Pin Configuration and Function Descriptions	7	Evaluation Board	24
Typical Performance Characteristics	9	Evaluation Board Control Software	24
RF Frequency Sweep	9	Schematic and Artwork	26
IF Frequency Sweep	10	Evaluation Board Configuration Options	28
Spurious Performance	15	Outline Dimensions	29
Register Structure	16	Ordering Guide	29
Register 0—Integer Divide Control (Default: 0x0001C0)	16	Changes to Programming the ADRF6603 Section	20
Register 1—Modulus Divide Control (Default: 0x003001) ..	16	Changes to Figure 46	22
Register 2—Fractional Divide Control (Default: 0x001802)	17	Added AC Test Fixture Section and Figure 47; Renumbered Sequentially	23
		Changes to Evaluation Board Control Software Section; Changes to Figure 48	24
		Changes to Figure 49	25
		Changes to Figure 50	26
		1/10—Revision 0: Initial Version	

REVISION HISTORY

11/10—Rev. 0 to Rev. A

Changes to Features and General Description	1
Changes to Table 1	1
Changes to Table 2	3
Changes to Table 3 and Table 4	4
Changes to Table 6	6
Change to Table 7, Pin 36 Description	8
Changes to Typical Performance Characteristics Section	9
Added Spurious Performance Section	15

SPECIFICATIONS

RF SPECIFICATIONS

$V_S = 5\text{ V}$; ambient temperature (T_A) = 25°C ; $f_{\text{REF}} = 153.6\text{ MHz}$; $f_{\text{PFD}} = 38.4\text{ MHz}$; high-side LO injection; $f_{\text{IF}} = 140\text{ MHz}$; IIP3 optimized using CDAC (0x1) and IP3SET (3.3 V), unless otherwise noted.

Table 2.

Parameter	Test Conditions/Comments	Min	Typ	Max	Unit
INTERNAL LO FREQUENCY RANGE		2100		2600	MHz
RF INPUT FREQUENCY RANGE	$\pm 3\text{ dB}$ RF input range	1100		3200	MHz
RF INPUT AT 2140 MHz					
Input Return Loss	Relative to $50\ \Omega$ (can be improved with external match)		<(-20)		dB
Input P1dB			14.9		dBm
Second-Order Intercept (IIP2)	-5 dBm each tone (10 MHz spacing between tones)		55.3		dBm
Third-Order Intercept (IIP3)	-5 dBm each tone (10 MHz spacing between tones)		29.3		dBm
Single-Side Band Noise Figure	IP3SET = 3.3 V		15.6		dB
	IP3SET = open		14.4		dB
LO-to-IF Leakage	At $1\times$ LO frequency, $50\ \Omega$ termination at the RF port		-43		dBm
RF INPUT AT 2400 MHz					
Input Return Loss	Relative to $50\ \Omega$ (can be improved with external match)		-16		dB
Input P1dB			14.9		dBm
Second-Order Intercept (IIP2)	-5 dBm each tone (10 MHz spacing between tones)		55.1		dBm
Third-Order Intercept (IIP3)	-5 dBm each tone (10 MHz spacing between tones)		28.6		dBm
Single-Side Band Noise Figure	IP3SET = 3.3 V		15.8		dB
	IP3SET = open		14.2		dB
LO-to-IF Leakage	At $1\times$ LO frequency, $50\ \Omega$ termination at the RF port		-43		dBm
RF INPUT AT 2650 MHz					
Input Return Loss	Relative to $50\ \Omega$ (can be improved with external match)		-11		dB
Input P1dB			14.7		dBm
Second-Order Intercept (IIP2)	-5 dBm each tone (10 MHz spacing between tones)		52.1		dBm
Third-Order Intercept (IIP3)	-5 dBm each tone (10 MHz spacing between tones)		28.1		dBm
Single-Side Band Noise Figure	IP3SET = 3.3 V		15.8		dB
	IP3SET = open		14.5		dB
LO-to-IF Leakage	At $1\times$ LO frequency, $50\ \Omega$ termination at the RF port		-44		dBm
IF OUTPUT					
Voltage Conversion Gain	Differential $200\ \Omega$ load		6.7		dB
IF Bandwidth	Small signal 3 dB bandwidth		500		MHz
Output Common-Mode Voltage	External pull-up balun or inductors required		5		V
Gain Flatness	Over frequency range, any 5 MHz/50 MHz		0.2/1.0		dB
Gain Variation	Over full temperature range		1.2		dB
Output Swing	Differential $200\ \Omega$ load		2		V p-p
Differential Output Return Loss	Measured through 4:1 balun		-15		dB
LO INPUT/OUTPUT (LOP, LON)	Externally applied $1\times$ LO input, internal PLL disabled				
Frequency Range		250		6000	MHz
Output Level (LO as Output)	$1\times$ LO into a $50\ \Omega$ load, LO output buffer enabled		-7		dBm
Input Level (LO as Input)		-6	0	+6	dBm
Input Impedance			50		Ω

ADRF6603

SYNTHESIZER/PLL SPECIFICATIONS

$V_S = 5\text{ V}$; ambient temperature (T_A) = 25°C ; $f_{\text{REF}} = 153.6\text{ MHz}$; $f_{\text{REF}} \text{ power} = 4\text{ dBm}$; $f_{\text{PFD}} = 38.4\text{ MHz}$; high-side LO injection; $f_{\text{IF}} = 140\text{ MHz}$; IIP3 optimized using CDAC (0x1) and IP3SET (3.3 V), unless otherwise noted.

Table 3.

Parameter	Test Conditions/Comments	Min	Typ	Max	Unit
SYNTHESIZER SPECIFICATIONS					
Frequency Range	Synthesizer specifications referenced to $1 \times \text{LO}$ Internally generated LO	2100		2600	MHz
Figure of Merit ¹	$P_{\text{REF_IN}} = 0\text{ dBm}$		-222		dBc/Hz/Hz
Reference Spurs	$f_{\text{PFD}} = 38.4\text{ MHz}$ $f_{\text{PFD}}/4$ f_{PFD} $>f_{\text{PFD}}$		-107 -82 -85		dBc dBc dBc
PHASE NOISE					
	$f_{\text{LO}} = 2100\text{ MHz to }2600\text{ MHz}$, $f_{\text{PFD}} = 38.4\text{ MHz}$ 1 kHz to 10 kHz offset		-88		dBc/Hz
	100 kHz offset		-99.5		dBc/Hz
	500 kHz offset		-120		dBc/Hz
	1 MHz offset		-128		dBc/Hz
	5 MHz offset		-142		dBc/Hz
	10 MHz offset		-148		dBc/Hz
	20 MHz offset		-150		dBc/Hz
Integrated Phase Noise	1 kHz to 40 MHz integration bandwidth		0.42		$^\circ\text{rms}$
PFD Frequency		20		40	MHz
REFERENCE CHARACTERISTICS					
REF_IN Input Frequency	REF_IN, MUXOUT pins	12		160	MHz
REF_IN Input Capacitance			4		pF
MUXOUT Output Level	V_{OL} (lock detect output selected) V_{OH} (lock detect output selected)			0.25	V V
MUXOUT Duty Cycle			50		%
CHARGE PUMP					
Pump Current	Programmable to 250 μA , 500 μA , 750 μA , 1 mA		500		μA
Output Compliance Range		1		2.8	V

¹ The figure of merit (FOM) is computed as phase noise (dBc/Hz) - $10\text{Log}_{10}(f_{\text{PFD}}) - 20\text{Log}_{10}(f_{\text{LO}}/f_{\text{PFD}})$. The FOM was measured across the full LO range, with $f_{\text{REF}} = 80\text{ MHz}$, and $f_{\text{REF}} \text{ power} = 10\text{ dBm}$ (500 V/ μs slew rate) with a 40 MHz f_{PFD} . The FOM was computed at 50 kHz offset.

LOGIC INPUT AND POWER SPECIFICATIONS

$V_S = 5\text{ V}$; ambient temperature (T_A) = 25°C ; $f_{\text{REF}} = 153.6\text{ MHz}$; $f_{\text{PFD}} = 38.4\text{ MHz}$; high-side LO injection; $f_{\text{IF}} = 140\text{ MHz}$; IIP3 optimized using CDAC (0x1) and IP3SET (3.3 V), unless otherwise noted.

Table 4.

Parameter	Test Conditions/Comments	Min	Typ	Max	Unit
LOGIC INPUTS					
	CLK, DATA, LE				
Input High Voltage, V_{INH}		1.4		3.3	V
Input Low Voltage, V_{INL}		0		0.7	V
Input Current, $I_{\text{INH}}/I_{\text{INL}}$			0.1		μA
Input Capacitance, C_{IN}			5		pF
POWER SUPPLIES					
	VCC1, VCC2, VCC_LO, VCC_MIX, and VCC_V2I pins				
Voltage Range		4.75	5	5.25	V
Supply Current	PLL only		97		mA
	External LO mode (internal PLL disabled, LO output buffer off, IP3SET pin = 3.3 V)		164		mA
	Internal LO mode (internal PLL enabled, IP3SET pin = 3.3 V, LO output buffer on)		274		mA
	Internal LO mode (internal PLL enabled, IP3SET pin = 3.3 V, LO output buffer off)		261		mA
	Power-down mode		30		mA

TIMING CHARACTERISTICS

VCC2 = 5 V ± 5%.

Table 5.

Parameter	Limit	Unit	Description
t ₁	20	ns min	LE setup time
t ₂	10	ns min	DATA-to-CLK setup time
t ₃	10	ns min	DATA-to-CLK hold time
t ₄	25	ns min	CLK high duration
t ₅	25	ns min	CLK low duration
t ₆	10	ns min	CLK-to-LE setup time
t ₇	20	ns min	LE pulse width

Timing Diagram

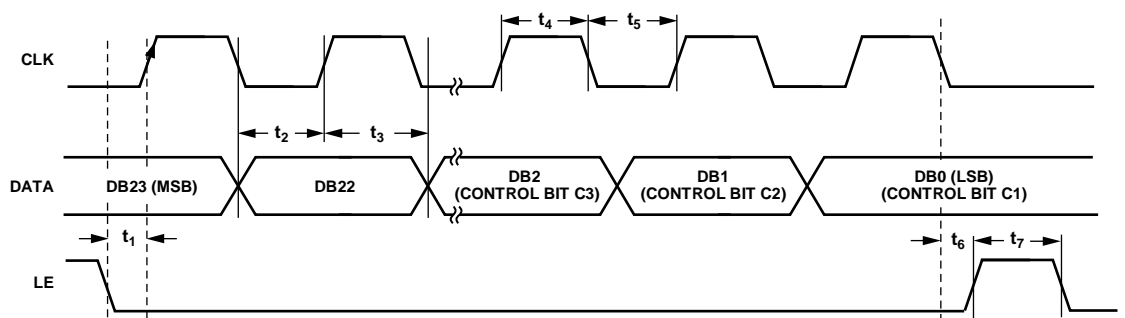

Figure 2. Timing Diagram

08547-902

ABSOLUTE MAXIMUM RATINGS

Table 6.

Parameter	Rating
Supply Voltage, VCC1, VCC2, VCC_LO, VCC_MIX, VCC_V2I	-0.5 V to +5.5 V
Digital I/O, CLK, DATA, LE, LODRV_EN, PLL_EN	-0.3 V to +3.6 V
VTUNE	0 V to 3.3 V
IFP, IFN	-0.3 V to VCC_V2I + 0.3 V
RF _{IN}	16 dBm
LOP, LON, REF_IN	13 dBm
θ _{JA} (Exposed Paddle Soldered Down)	35°C/W
Maximum Junction Temperature	150°C
Operating Temperature Range	-40°C to +85°C
Storage Temperature Range	-65°C to +150°C

Stresses above those listed under Absolute Maximum Ratings may cause permanent damage to the device. This is a stress rating only; functional operation of the device at these or any other conditions above those indicated in the operational section of this specification is not implied. Exposure to absolute maximum rating conditions for extended periods may affect device reliability.

ESD CAUTION



ESD (electrostatic discharge) sensitive device. Charged devices and circuit boards can discharge without detection. Although this product features patented or proprietary protection circuitry, damage may occur on devices subjected to high energy ESD. Therefore, proper ESD precautions should be taken to avoid performance degradation or loss of functionality.

PIN CONFIGURATION AND FUNCTION DESCRIPTIONS

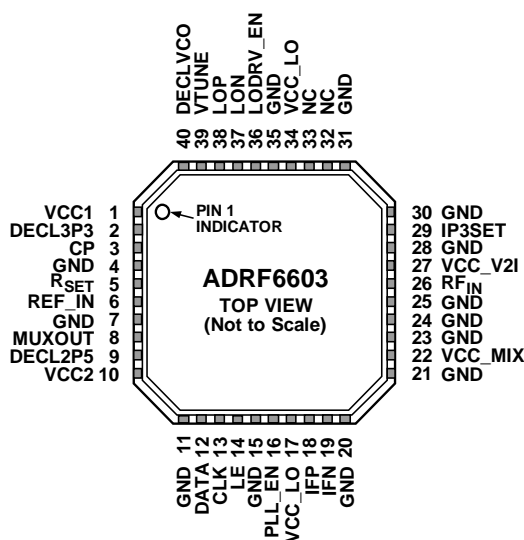

- NOTES**
1. NC = NO CONNECT.
 2. THE EXPOSED PADDLE SHOULD BE SOLDERED TO A LOW IMPEDANCE GROUND PLANE.

09547-003

Figure 3. Pin Configuration

Table 7. Pin Function Descriptions

Pin No.	Mnemonic	Description
1	VCC1	Power Supply for the 3.3 V LDO. Power supply voltage range is 4.75 V to 5.25 V. Each power supply pin should be decoupled with a 100 pF capacitor and a 0.1 μF capacitor located close to the pin.
2	DECL3P3	Decoupling Node for 3.3 V LDO. Connect a 0.1 μF capacitor between this pin and ground.
3	CP	Charge Pump Output Pin. Connect to VTUNE through the loop filter.
4, 7, 11, 15, 20, 21, 23, 24, 25, 28, 30, 31, 35	GND	Ground. Connect these pins to a low impedance ground plane.
5	R _{SET}	Charge Pump Current. The nominal charge pump current can be set to 250 μA, 500 μA, 750 μA, or 1 mA using Bit DB11 and Bit DB10 in Register 4 and by setting Bit DB18 in Register 4 to 0 (internal reference current). In this mode, no external R _{SET} is required. If Bit DB18 is set to 1, the four nominal charge pump currents (I _{NOMINAL}) can be externally adjusted according to the following equation: $R_{SET} = \left(\frac{217.4 \times I_{CP}}{I_{NOMINAL}} \right) - 37.8 \Omega$
6	REF_IN	Reference Input. Nominal input level is 1 V p-p. Input range is 12 MHz to 160 MHz. This pin is internally dc-biased and should be ac-coupled.
8	MUXOUT	Multiplexer Output. This output can be programmed to provide the reference output signal or the lock detect signal. The output is selected by programming the appropriate register.
9	DECL2P5	Decoupling Node for 2.5 V LDO. Connect a 0.1 μF capacitor between this pin and ground.
10	VCC2	Power Supply for the 2.5 V LDO. Power supply voltage range is 4.75 V to 5.25 V. Each power supply pin should be decoupled with a 100 pF capacitor and a 0.1 μF capacitor located close to the pin.
12	DATA	Serial Data Input. The serial data input is loaded MSB first; the three LSBs are the control bits.
13	CLK	Serial Clock Input. The serial clock input is used to clock in the serial data to the registers. The data is latched into the 24-bit shift register on the CLK rising edge. Maximum clock frequency is 20 MHz.
14	LE	Load Enable. When the LE input pin goes high, the data stored in the shift registers is loaded into one of the eight registers. The relevant latch is selected by the three control bits of the 24-bit word.
16	PLL_EN	PLL Enable. Switch between internal PLL and external LO input. When this pin is logic high, the mixer LO is automatically switched to the internal PLL and the internal PLL is powered up. When this pin is logic low, the internal PLL is powered down and the external LO input is routed to the mixer LO inputs. The SPI can also be used to switch modes.

ADRF6603

Pin No.	Mnemonic	Description
17, 34	VCC_LO	Power Supply. Power supply voltage range is 4.75 V to 5.25 V. Each power supply pin should be decoupled with a 100 pF capacitor and a 0.1 μ F capacitor located close to the pin.
18, 19	IFP, IFN	Mixer IF Outputs. These outputs should be pulled to VCC with RF chokes.
22	VCC_MIX	Power Supply. Power supply voltage range is 4.75 V to 5.25 V. Each power supply pin should be decoupled with a 100 pF capacitor and a 0.1 μ F capacitor located close to the pin.
26	RF _{IN}	RF Input (Single-Ended, 50 Ω).
27	VCC_V2I	Power Supply. Power supply voltage range is 4.75 V to 5.25 V. Each power supply pin should be decoupled with a 100 pF capacitor and a 0.1 μ F capacitor located close to the pin.
29	IP3SET	Connect a resistor from this pin to a 5 V supply to adjust IIP3. Normally leave open.
32, 33	NC	No Connection.
36	LODRV_EN	LO Driver Enable. Together with Pin 16 (PLL_EN), this digital input pin determines whether the LOP and LON pins operate as inputs or outputs. LOP and LON become inputs if the PLL_EN pin is low or if the PLL_EN pin is set high with the PLEN bit (DB6 in Register 5) set to 0. LOP and LON become outputs if either the LODRV_EN pin or the LDRV bit (DB3 in Register 5) is set to 1 while the PLL_EN pin is set high. External LO drive frequency must be 1 \times LO. This pin has an internal 100 k Ω pull down resistor.
37, 38	LON, LOP	Local Oscillator Input/Output. The internally generated 1 \times LO is available on these pins. When internal LO generation is disabled, an external 1 \times LO can be applied to these pins.
39	VTUNE	VCO Control Voltage Input. This pin is driven by the output of the loop filter. Nominal input voltage range on this pin is 1.5 V to 2.5 V.
40	DECLVCO	Decoupling Node for VCO LDO. Connect a 100 pF capacitor and a 10 μ F capacitor between this pin and ground.
	EPAD	Exposed Paddle. The exposed paddle should be soldered to a low impedance ground plane.

TYPICAL PERFORMANCE CHARACTERISTICS

RF FREQUENCY SWEEP

CDAC = 0x1, internally generated high-side LO, $RF_{IN} = -5$ dBm, $f_{IF} = 140$ MHz, unless otherwise noted.

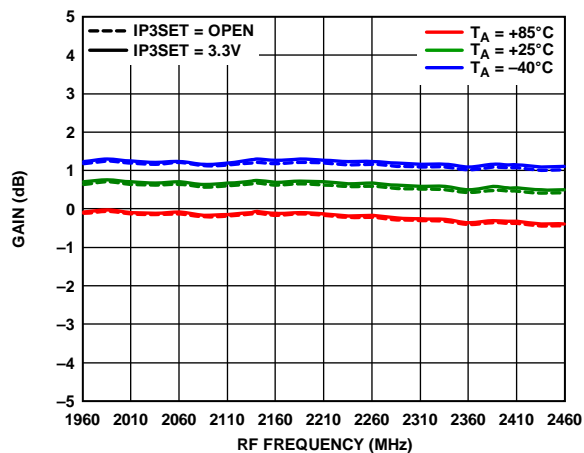

Figure 4. Gain vs. RF Frequency

08547-104

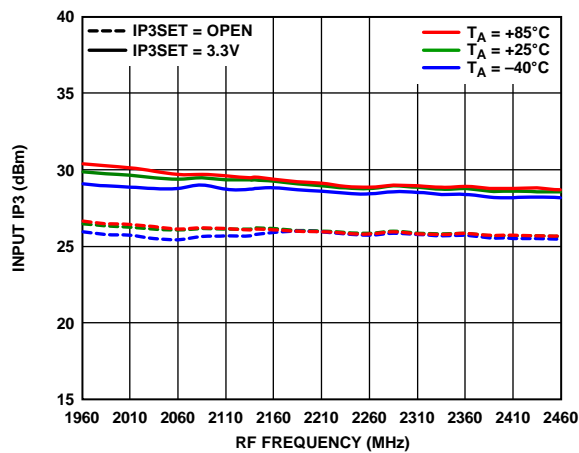

Figure 7. Input IP3 vs. RF Frequency

08547-107

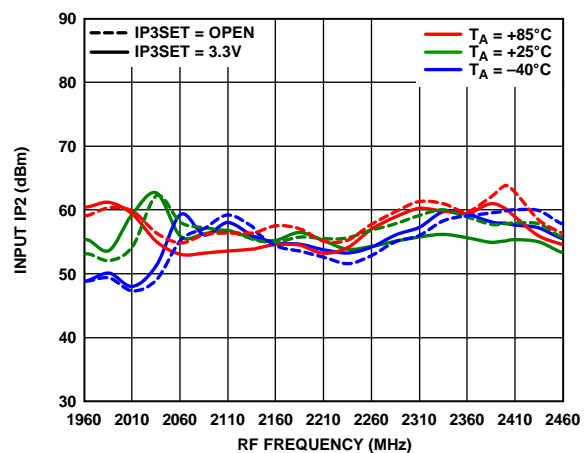

Figure 5. Input IP2 vs. RF Frequency

08547-105

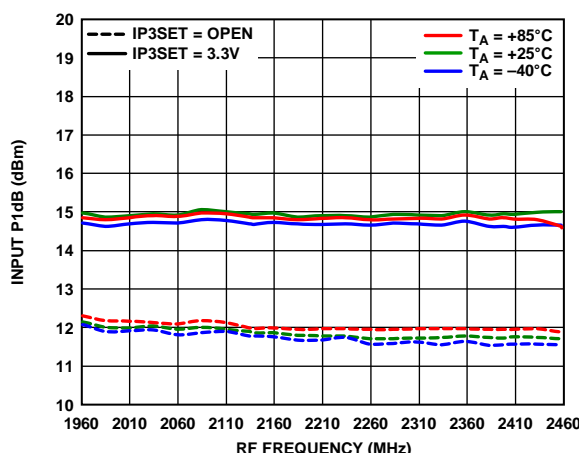

Figure 8. Input P1dB vs. RF Frequency

08547-108

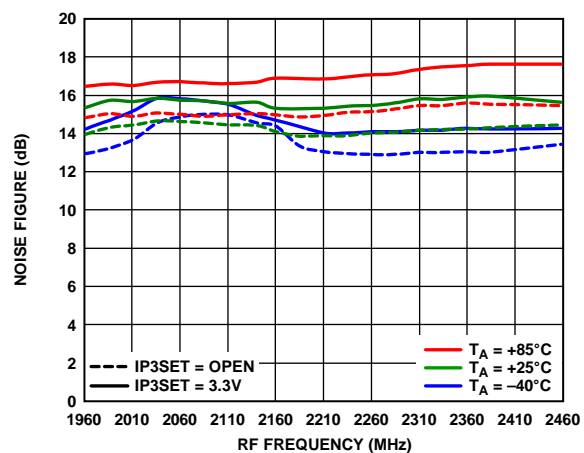

Figure 6. Noise Figure vs. RF Frequency

08547-106

ADRF6603

IF FREQUENCY SWEEP

CDAC = 0x1, internally generated swept low-side LO, $f_{RF} = 1960$ MHz, $RF_{IN} = -5$ dBm, unless otherwise noted.

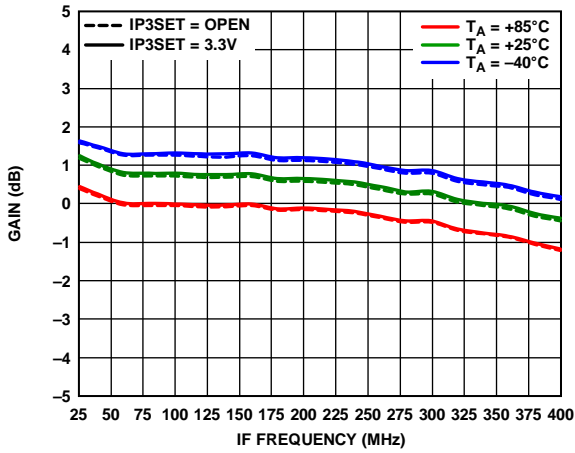

Figure 9. Gain vs. IF Frequency

08547-108

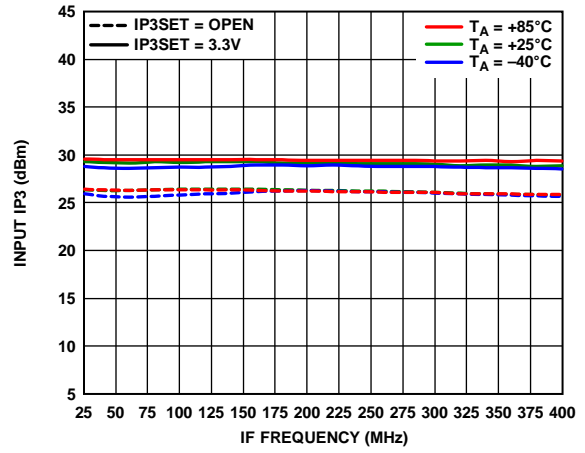

Figure 12. Input IP3 vs. IF Frequency, $RF_{IN} = -5$ dBm

08547-112

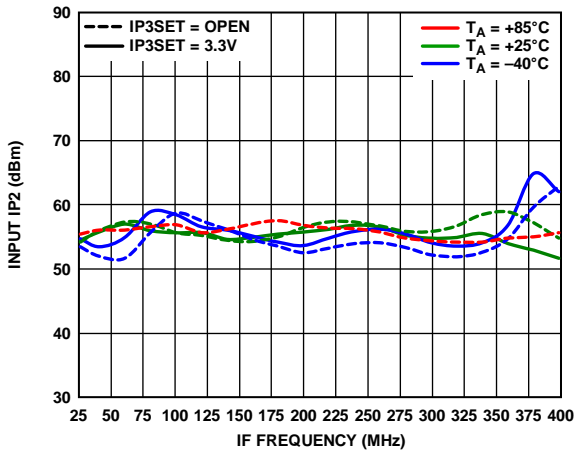

Figure 10. Input IP2 vs. IF Frequency, $RF_{IN} = -5$ dBm

08547-110

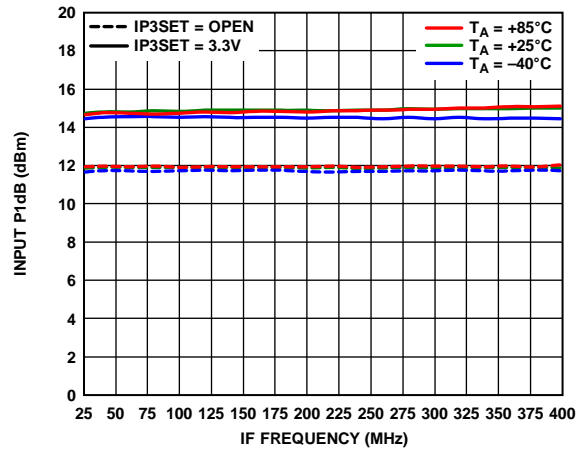

Figure 13. Input P1dB vs. IF Frequency

08547-113

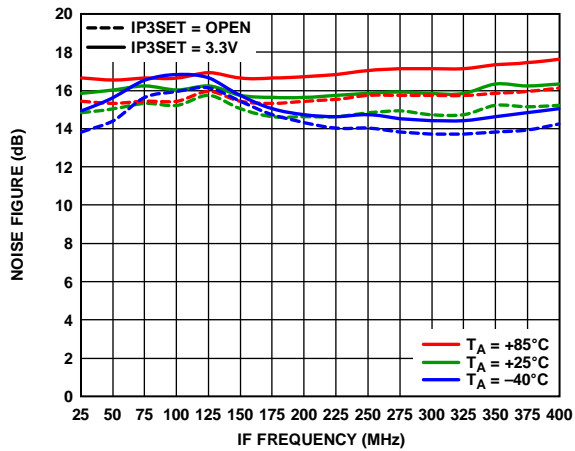

Figure 11. Noise Figure vs. IF Frequency

08547-111

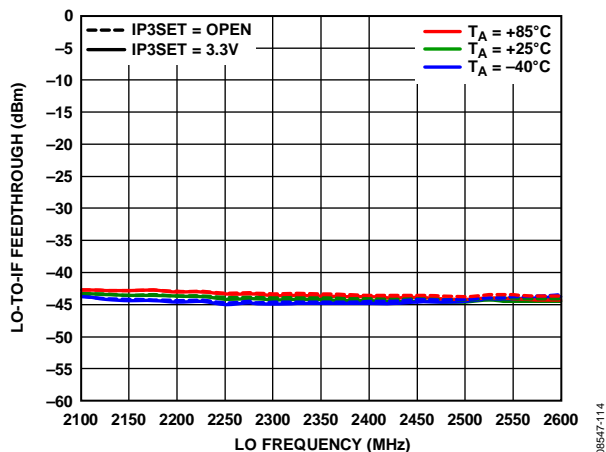

Figure 14. LO-to-IF Feedthrough vs. LO Frequency, LO Output Turned Off, CDAC = 0x0

08547-114

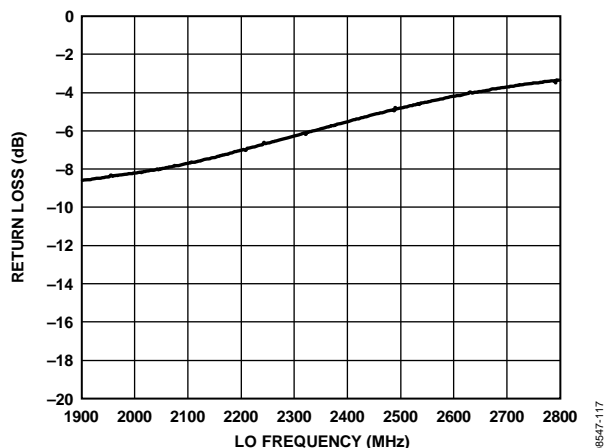

Figure 17. LO Input Return Loss vs. LO Frequency (Including TC1-1-13 Balun)

08547-117

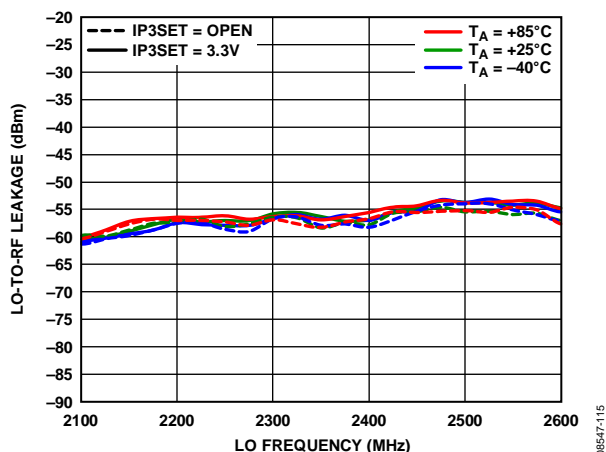

Figure 15. LO-to-RF Leakage vs. LO Frequency, LO Output Turned Off

08547-115

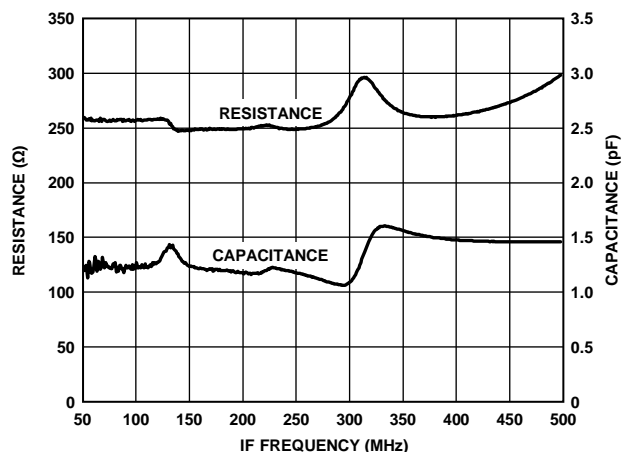

Figure 18. IF Differential Output Impedance (R Parallel C Equivalent)

08547-118

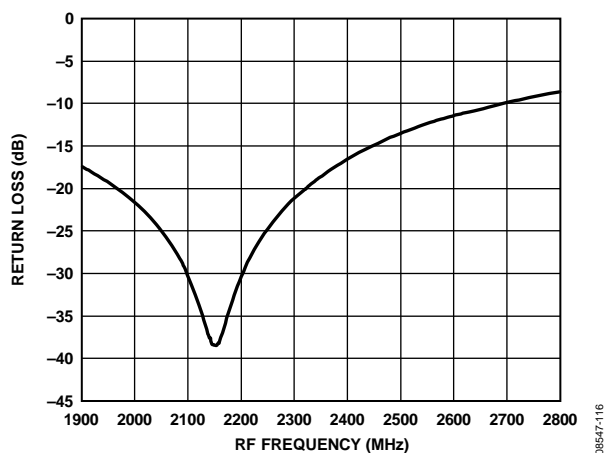

Figure 16. RF Input Return Loss vs. RF Frequency

08547-116

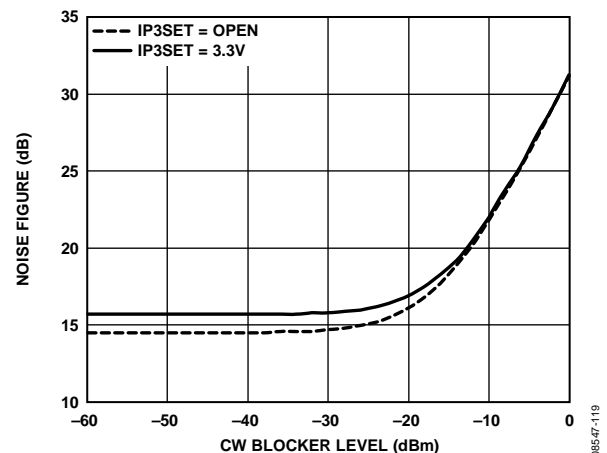

Figure 19. SSB Noise Figure vs. 5 MHz Offset Blocker Level, LO Frequency = 2105 MHz, RF Frequency = 1965 MHz

08547-119

ADRF6603

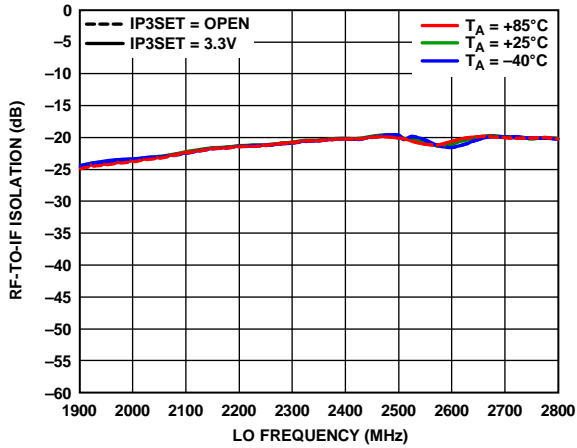

Figure 20. RF-to-IF Isolation vs. RF Frequency, High-Side LO, IF = 140 MHz, LO Output Turned Off

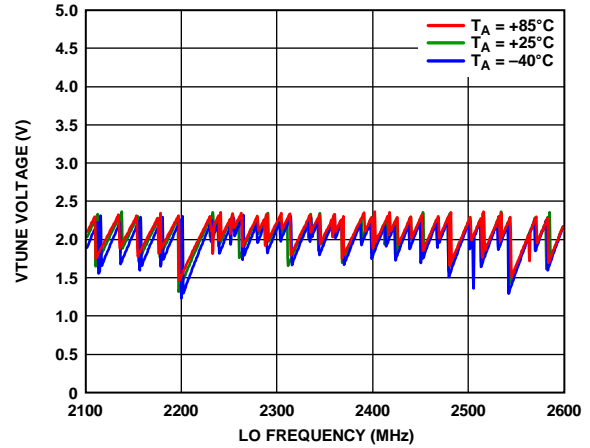

Figure 23. VTUNE vs. LO Frequency

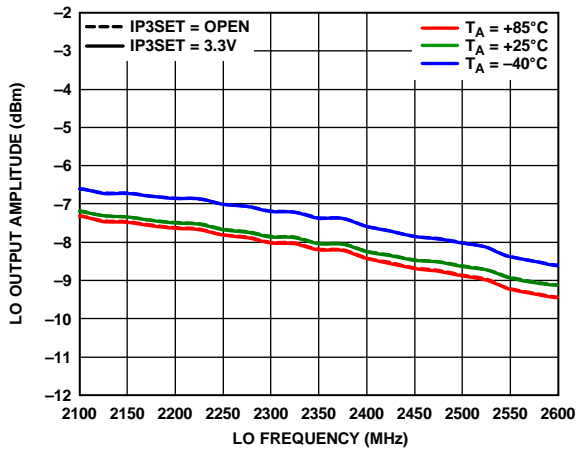

Figure 21. LO Output Amplitude vs. LO Frequency

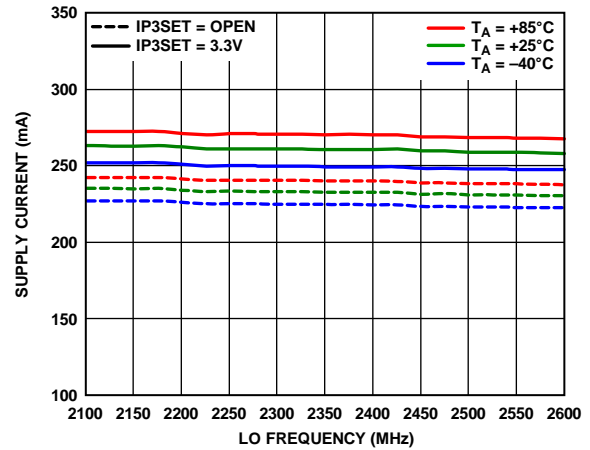

Figure 24. Supply Current vs. LO Frequency

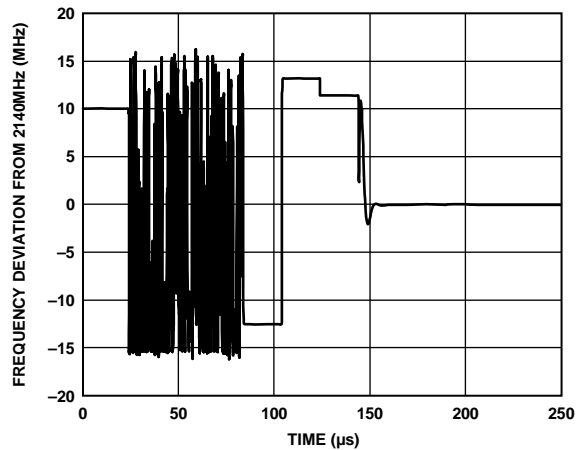

Figure 22. Frequency Deviation from 2140 MHz vs Time (Demonstrates LO Frequency Settling Time from 2150 MHz to 2140 MHz)

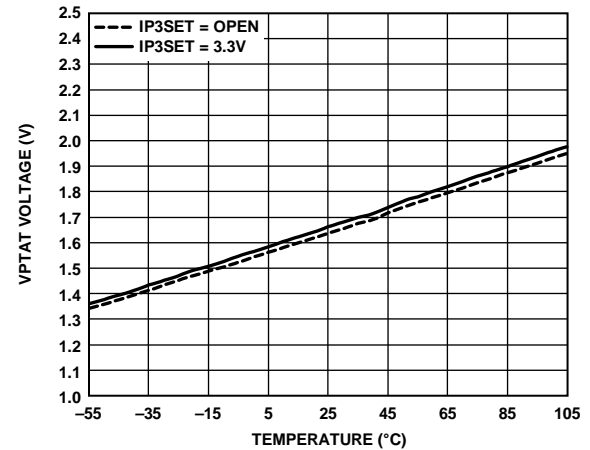

Figure 25. VPTAT Voltage vs. Temperature (IP3SET = Optimized, Open)

Complementary cumulative distribution function (CCDF), $f_{RF} = 2140$ MHz, $f_{IF} = 140$ MHz.

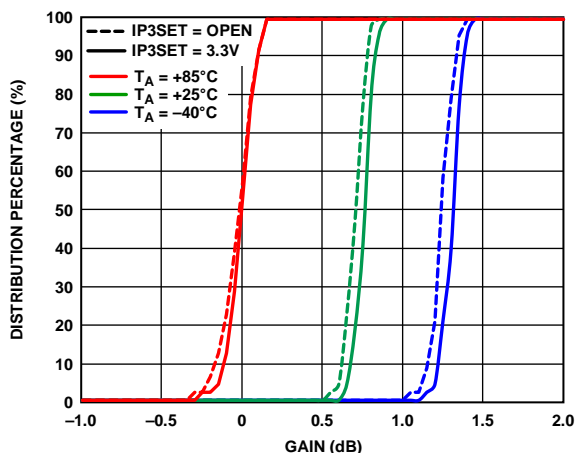

Figure 26. Gain

08547-126

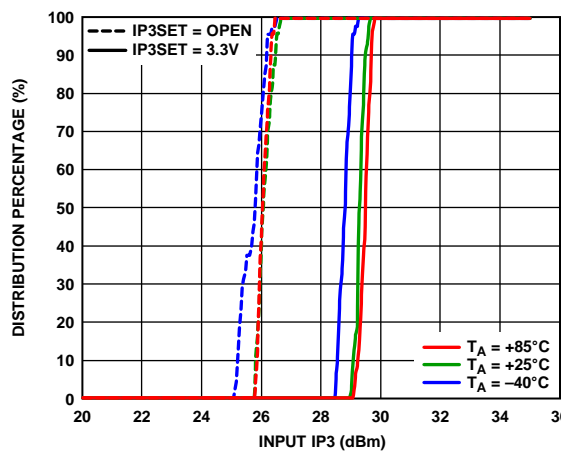

Figure 29. Input IP3

08547-129

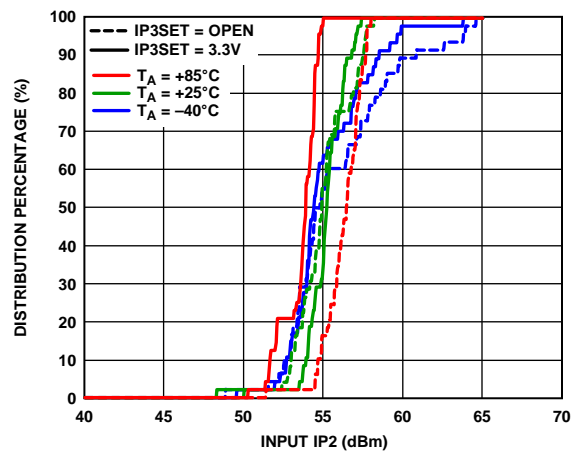

Figure 27. Input IP2

08547-127

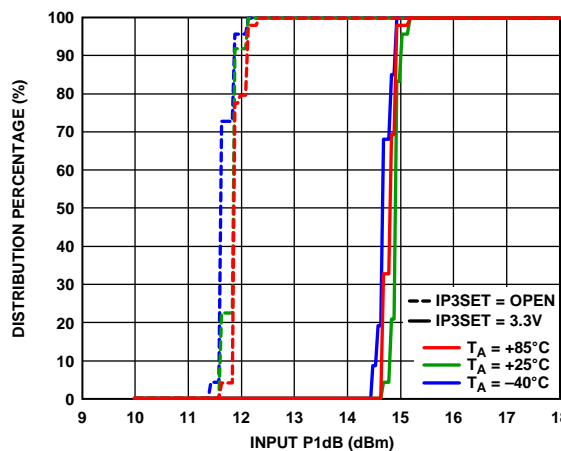

Figure 30. Input P1dB

08547-130

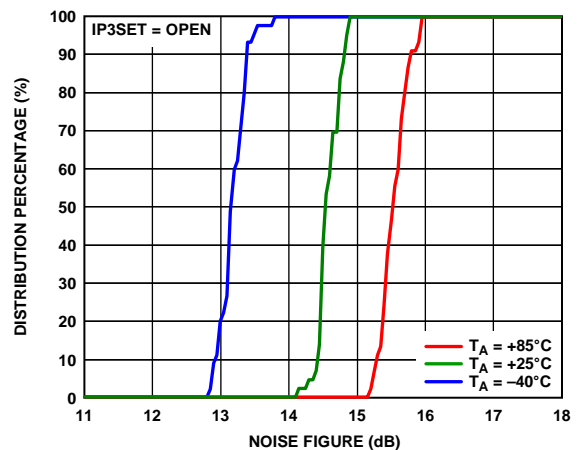

Figure 28. Noise Figure

08547-128

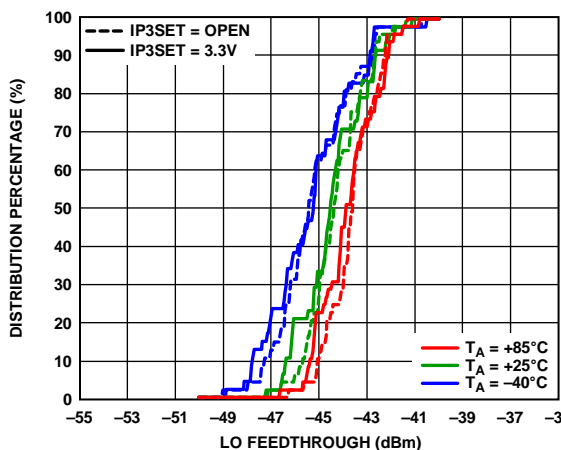

Figure 31. LO Feedthrough to IF, LO Output Turned Off

08547-131

ADRF6603

Measured at IF output, CDAC = 0x1, IP3SET = open, internally generated high-side LO, $f_{REF} = 153.6$ MHz, $f_{PFD} = 38.4$ MHz, $RF_{IN} = -5$ dBm, $f_{IF} = 140$ MHz, unless otherwise noted. Phase noise measurements made at LO output, unless otherwise noted.

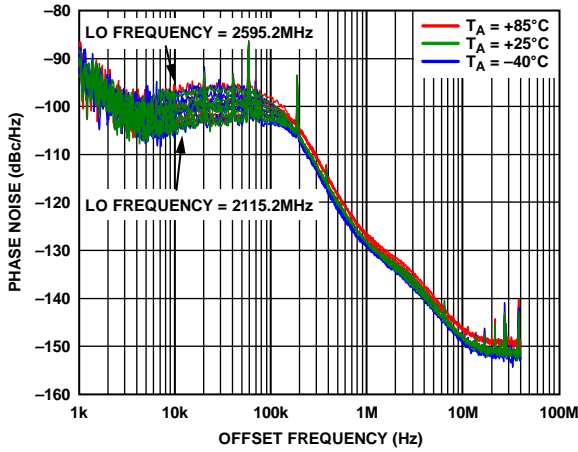

Figure 32. Phase Noise vs. Offset Frequency

09547-132

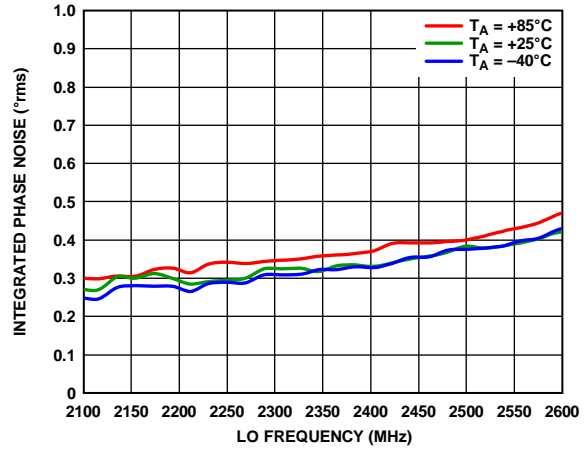

Figure 35. Integrated Phase Noise vs. LO Frequency

09547-135

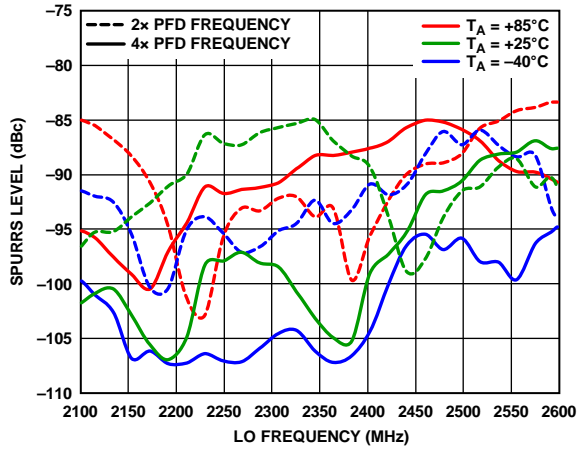

Figure 33. PLL Reference Spurs vs. LO Frequency (2x PFD and 4x PFD)

09547-133

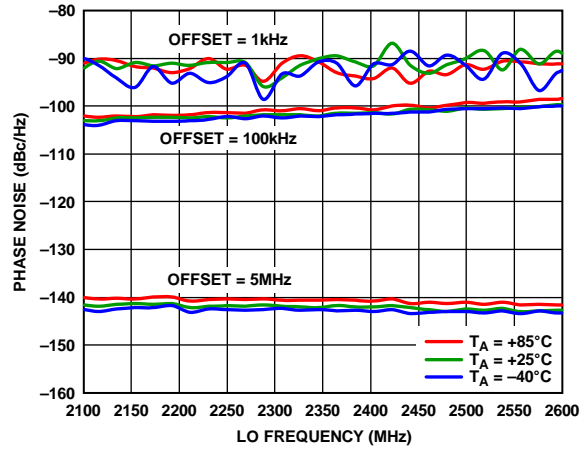

Figure 36. Phase Noise vs. LO Frequency (1 kHz, 100 kHz, and 5 MHz Steps)

09547-136

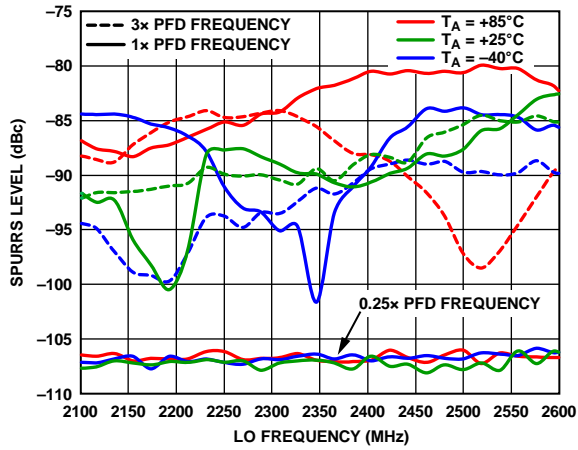

Figure 34. PLL Reference Spurs vs. LO Frequency (0.25x PFD, 1x PFD, and 3x PFD)

09547-134

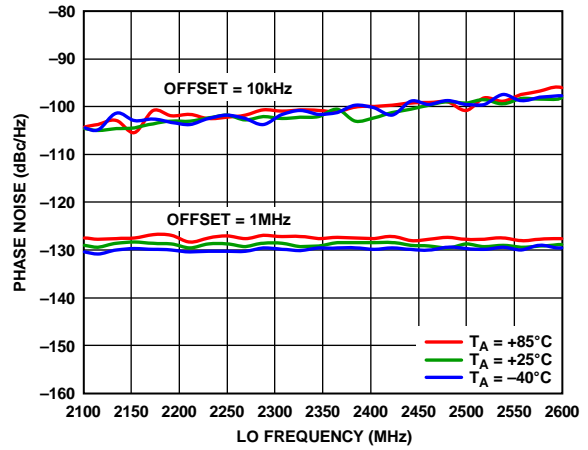

Figure 37. Phase Noise vs. LO Frequency (10 kHz, 1 MHz Steps)

09547-137

SPURIOUS PERFORMANCE

$(N \times f_{RF}) - (M \times f_{LO})$ spur measurements were made using the standard evaluation board (see the Evaluation Board section). Mixer spurious products were measured in dB relative to the carrier (dBc) from the IF output power level. All spurious components greater than -125 dBc are shown.

LO = 2280 MHz, RF = 2140 MHz (horizontal axis is m, vertical axis is n), and RF_{IN} power = 0 dBm.

		M				
		0	1	2	3	4
N	0	-114.35	-45.19	-36.94		
	1	-20.79	0.0	-67.43	-52.11	
	2	-58.20	-61.95	-78.15	-85.93	-93.10
	3		-71.79	-91.89	-67.46	-105.88
	4			-107.79	-110.27	-107.87
	5				-107.88	-112.41
	6					-107.71
	7					-108.62

LO = 2540 MHz, RF = 2400 MHz (horizontal axis is m, vertical axis is n), and RF_{IN} power = 0 dBm.

		M				
		0	1	2	3	4
N	0	-113.65	-47.04	-36.36		
	1	-18.91	0.0	-65.01	-56.24	
	2	-59.08	-60.49	-69.27	-89.85	-94.25
	3		-77.54	-89.56	-68.39	-109.30
	4			-108.79	-110.65	-111.94
	5				-108.85	-111.54
	6					-108.89
	7					

LO = 2650 MHz, RF = 2510 MHz (horizontal axis is m, vertical axis is n), and RF_{IN} power = 0 dBm.

		M				
		0	1	2	3	4
N	0	-111.38	-46.57	-36.03		
	1	-17.70	0.0	-65.70	-54.37	
	2	-58.49	-75.49	-72.27	-71.05	-95.32
	3		-81.35	-89.18	-68.23	-103.38
	4			-106.13	-106.74	-112.72
	5				-107.26	-105.45
	6					-110.74
	7					

ADRF6603

REGISTER STRUCTURE

This section provides the register maps for the ADRF6603. The three LSBs determine the register that is programmed.

REGISTER 0—INTEGER DIVIDE CONTROL (DEFAULT: 0x0001C0)

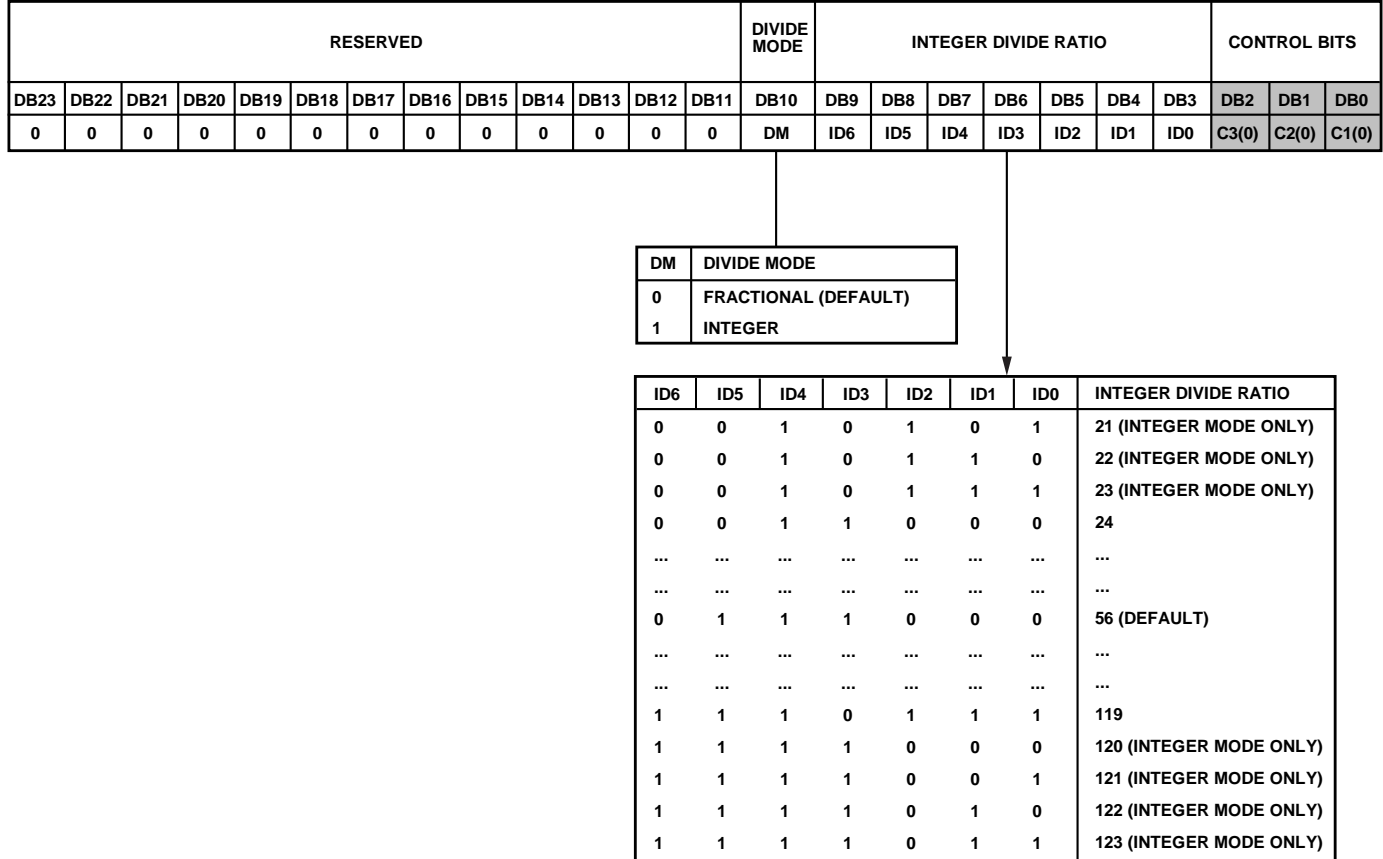

Figure 38. Register 0—Integer Divide Control Register Map

08547-004

REGISTER 1—MODULUS DIVIDE CONTROL (DEFAULT: 0x003001)

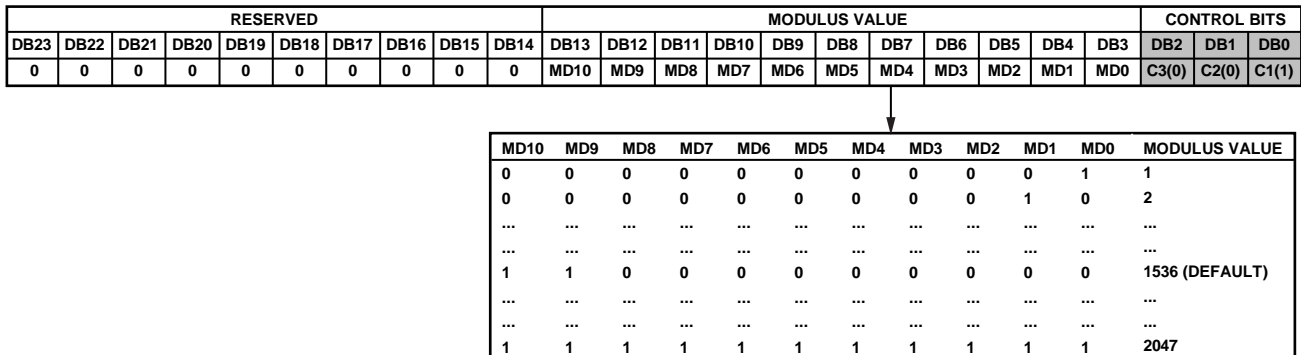

Figure 39. Register 1—Modulus Divide Control Register Map

08547-005

REGISTER 2—FRACTIONAL DIVIDE CONTROL (DEFAULT: 0x001802)

RESERVED										FRACTIONAL VALUE										CONTROL BITS			
DB23	DB22	DB21	DB20	DB19	DB18	DB17	DB16	DB15	DB14	DB13	DB12	DB11	DB10	DB9	DB8	DB7	DB6	DB5	DB4	DB3	DB2	DB1	DB0
0	0	0	0	0	0	0	0	0	0	FD10	FD9	FD8	FD7	FD6	FD5	FD4	FD3	FD2	FD1	FD0	C3(0)	C2(1)	C1(0)

FD10	FD9	FD8	FD7	FD6	FD5	FD4	FD3	FD2	FD1	FD0	FRACTIONAL VALUE
0	0	0	0	0	0	0	0	0	0	0	0
0	0	0	0	0	0	0	0	0	0	1	1
...
...
0	1	1	0	0	0	0	0	0	0	0	768 (DEFAULT)
...
...
FRACTIONAL VALUE MUST BE LESS THAN MODULUS											<MDR

Figure 40. Register 2—Fractional Divide Control Register Map

REGISTER 3—Σ-Δ MODULATOR DITHER CONTROL (DEFAULT: 0x10000B)

DITHER MAGNITUDE			DITHER ENABLE	DITHER RESTART VALUE																CONTROL BITS			
DB23	DB22	DB21	DB20	DB19	DB18	DB17	DB16	DB15	DB14	DB13	DB12	DB11	DB10	DB9	DB8	DB7	DB6	DB5	DB4	DB3	DB2	DB1	DB0
0	DITH1	DITH0	DEN	DV16	DV15	DV14	DV13	DV12	DV11	DV10	DV9	DV8	DV7	DV6	DV5	DV4	DV3	DV2	DV1	DV0	C3(0)	C2(1)	C1(1)

DITH1	DITH0	DITHER MAGNITUDE
0	0	15 (DEFAULT)
0	1	7
1	0	3
1	1	1 (RECOMMENDED)

DEN	DITHER ENABLE
0	DISABLE
1	ENABLE (DEFAULT, RECOMMENDED)

DV16	DV15	DV14	DV13	DV12	DV11	DV10	DV9	DV8	DV7	DV6	DV5	DV4	DV3	DV2	DV1	DV0	DITHER RESTART VALUE
0	0	0	0	0	0	0	0	0	0	0	0	0	0	0	0	1	0x00001 (DEFAULT)
...
...
1	1	1	1	1	1	1	1	1	1	1	1	1	1	1	1	1	0x1FFFF

Figure 41. Register 3—Σ-Δ Modulator Dither Control Register Map

ADRF6603

REGISTER 4—PLL CHARGE PUMP, PFD, AND REFERENCE PATH CONTROL (DEFAULT: 0x0AA7E4)

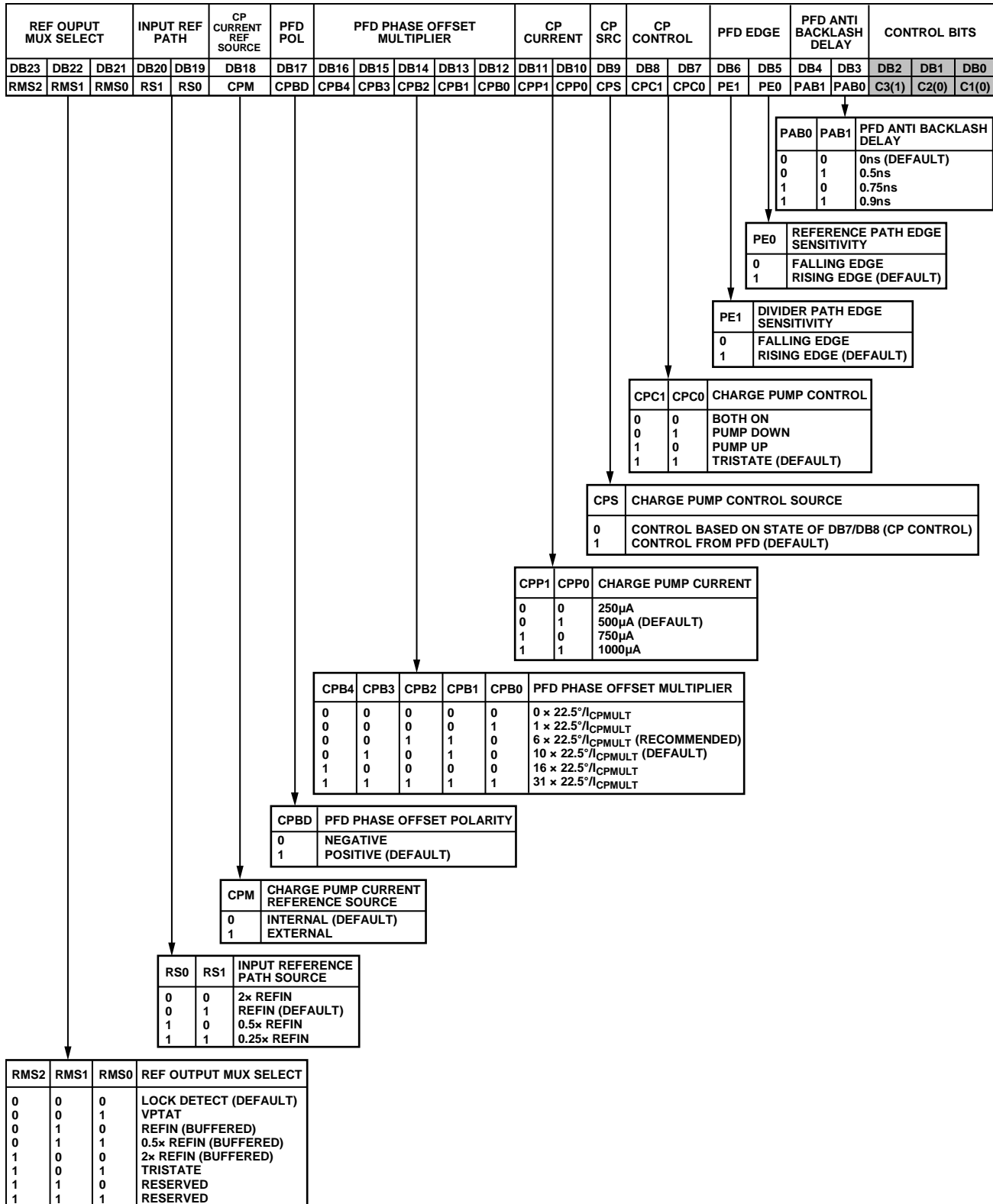

Figure 42. Register 4—PLL Charge Pump, PFD, and Reference Path Control Register Map

08547-208

REGISTER 5—PLL ENABLE AND LO PATH CONTROL (DEFAULT: 0x0000E5)

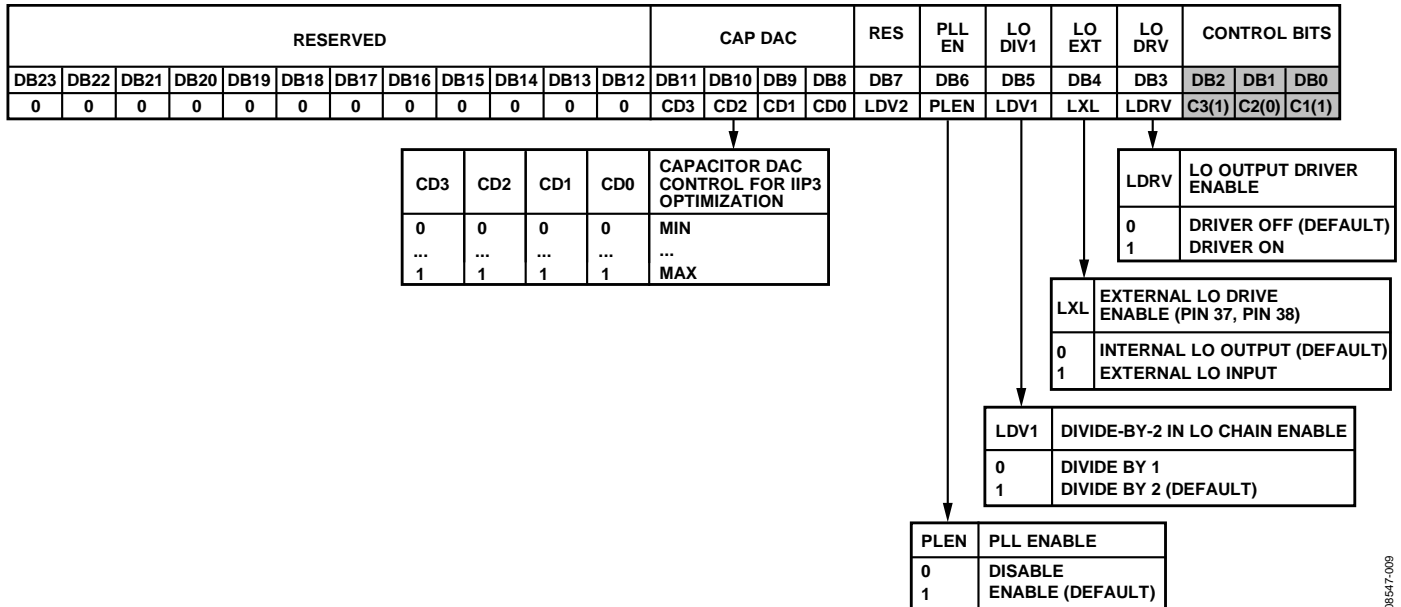

Figure 43. Register 5—PLL Enable and LO Path Control Register Map

REGISTER 6—VCO CONTROL AND VCO ENABLE (DEFAULT: 0x1E2106)

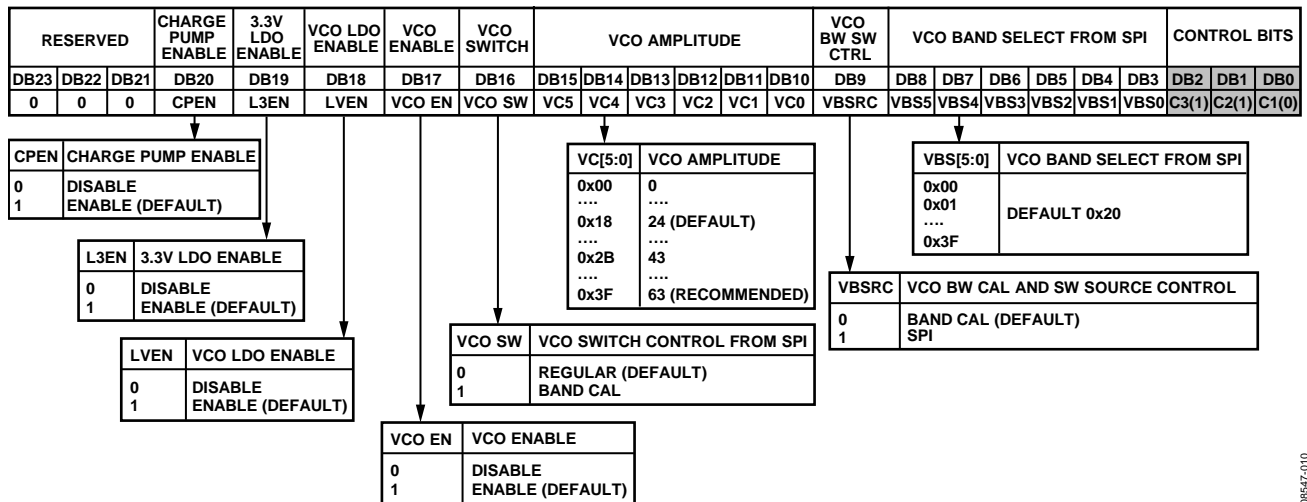

Figure 44. Register 6—VCO Control and VCO Enable Register Map

REGISTER 7—MIXER BIAS ENABLE AND EXTERNAL VCO ENABLE (DEFAULT: 0x000007)

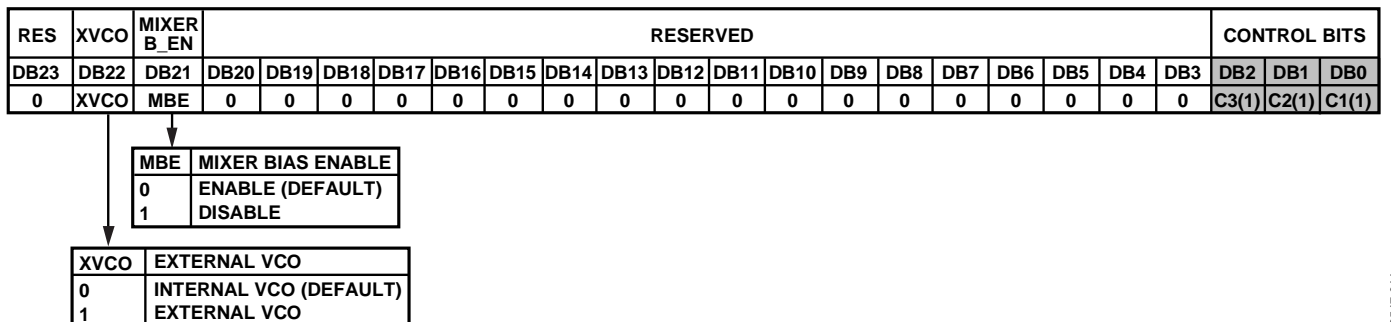

Figure 45. Register 7—Mixer Bias Enable and External VCO Enable Register Map

THEORY OF OPERATION

The ADRF6603 integrates a high performance downconverting mixer with a state-of-the-art fractional-N PLL. The PLL also integrates a low noise VCO. The SPI port allows the user to control the fractional-N PLL functions and the mixer optimization functions, as well as allowing for an externally applied LO or VCO.

The mixer core within the ADRF6603 is the next generation of an industry-leading family of mixers from Analog Devices, Inc. The RF input is converted to a current and then mixed down to IF using high performance NPN transistors. The mixer output currents are transformed to a differential output. The high performance active mixer core results in an exceptional IIP3 and IP1dB, with a very low output noise floor for excellent dynamic range. Over the specified frequency range, the ADRF6603 typically provides IF input P1dB of 14.6 dBm and IIP3 of 27 dBm.

Improved performance at specific frequencies can be achieved with the use of the internal capacitor DAC (CDAC), which is programmable via the SPI port, and by using a resistor to a 5 V supply from the IP3SET pin (Pin 29). Adjustment of the capacitor DAC allows increments in phase shift at internal nodes in the ADRF6603, thus allowing cancellation of third-order distortion with no change in supply current. Connecting a resistor to a 5 V supply from the IP3SET pin increases the internal mixer core current, thereby improving overall IIP2 and IIP3, as well as IP1dB. Using the IP3SET pin for this purpose increases the overall supply current.

The fractional divide function of the PLL allows the frequency multiplication value from REF_IN to LO output to be a fractional value rather than be restricted to an integer value as in traditional PLLs. In operation, this multiplication value is $INT + (FRAC/MOD)$, where INT is the integer value, FRAC is the fractional value, and MOD is the modulus value, all programmable via the SPI port. In other fractional-N PLL designs, fractional multiplication is achieved by periodically changing the fractional value in a deterministic way. The disadvantage of this approach is often spurious components close to the fundamental signal. In the ADRF6603, a Σ - Δ modulator is used to distribute the fractional value randomly, thus significantly reducing the spurious content due to the fractional function.

PROGRAMMING THE ADRF6603

The ADRF6603 is programmed via a 3-pin SPI port. The timing requirements for the SPI port are shown in Figure 2. Eight programmable registers, each with 24 bits, control the operation of the device. The register functions are listed in Table 8.

Table 8. ADRF6603 Register Functions

Register	Function
Register 0	Integer divide control for the PLL
Register 1	Modulus divide control for the PLL
Register 2	Fractional divide control for the PLL
Register 3	Σ - Δ modulator dither control
Register 4	PLL charge pump, PFD, reference path control
Register 5	PLL enable and LO path control
Register 6	VCO control and VCO enable
Register 7	Mixer bias enable and external VCO enable

Note that internal calibration for the PLL must be run when the ADRF6603 is initialized at a given frequency. This calibration is run automatically whenever Register 0, Register 1, or Register 2 is programmed. Because the other registers affect PLL performance, Register 0, Register 1, and Register 2 should always be programmed last and in this order: Register 0, Register 1, Register 2.

To program the frequency of the ADRF6603, the user typically programs only Register 0, Register 1, and Register 2. However, if registers other than these are programmed first, a short delay should be inserted before programming Register 0. This delay ensures that the VCO band calibration has sufficient time to complete before the final band calibration for Register 0 is initiated.

Software is available on the [ADRF6603](#) product page under the Evaluation Boards & Development Kits section that allows easy programming from a PC running Windows XP or Vista.

INITIALIZATION SEQUENCE

To ensure proper power-up of the ADRF6603, it is important to reset the PLL circuitry after the VCC supply rail settles to $5\text{ V} \pm 0.25\text{ V}$. Resetting the PLL ensures that the internal bias cells are properly configured, even under poor supply start-up conditions.

To ensure that the PLL is reset after power-up, follow this procedure:

1. Disable the PLL by setting the PLEN bit to 0 (Register 5, Bit DB6).
2. After a delay of >100 ms, set the PLEN bit to 1 (Register 5, Bit DB6).

After this procedure is followed, the other registers should be programmed in this order: Register 7, Register 6, Register 4, Register 3, Register 2, Register 1. Then, after a delay of >100 ms, Register 0 should be programmed.

LO SELECTION LOGIC

The downconverting mixer in the ADRF6603 can be used without the internal PLL by applying an external differential LO to Pin 37 and Pin 38 (LON and LOP). In addition, when using an LO generated by the internal PLL, the LO signal can be accessed directly at these same pins. This function can be used for debugging purposes, or the internally generated LO can be used as the LO for a separate mixer.

The operation of the LO generation and whether LOP and LON are inputs or outputs are determined by the logic levels applied at Pin 16 (PLL_EN) and Pin 36 (LODRV_EN), as well as Bit DB3 (LDRV) and Bit DB6 (PLEN) in Register 5. The combination of externally applied logic and internal bits required for particular LO functions is given in Table 9.

Table 9. LO Selection Logic

Pins ¹		Register 5 Bits ¹		Outputs	
Pin 16 (PLL_EN)	Pin 36 (LODRV_EN)	Bit DB6 (PLEN)	Bit DB3 (LDRV)	Output Buffer	LO
0	X	0	X	Disabled	External
0	X	1	X	Disabled	External
1	X	0	X	Disabled	External
1	0	1	0	Disabled	Internal
1	X	1	1	Enabled	Internal
1	1	1	X	Enabled	Internal

¹X = don't care.

AC TEST FIXTURE

Characterization data for the ADRF6603 was taken under very strict test conditions. All possible techniques were used to achieve optimum accuracy and to remove degrading effects of

the signal generation and measurement equipment. Figure 47 shows the typical AC test set up used in the characterization of the ADRF6603.

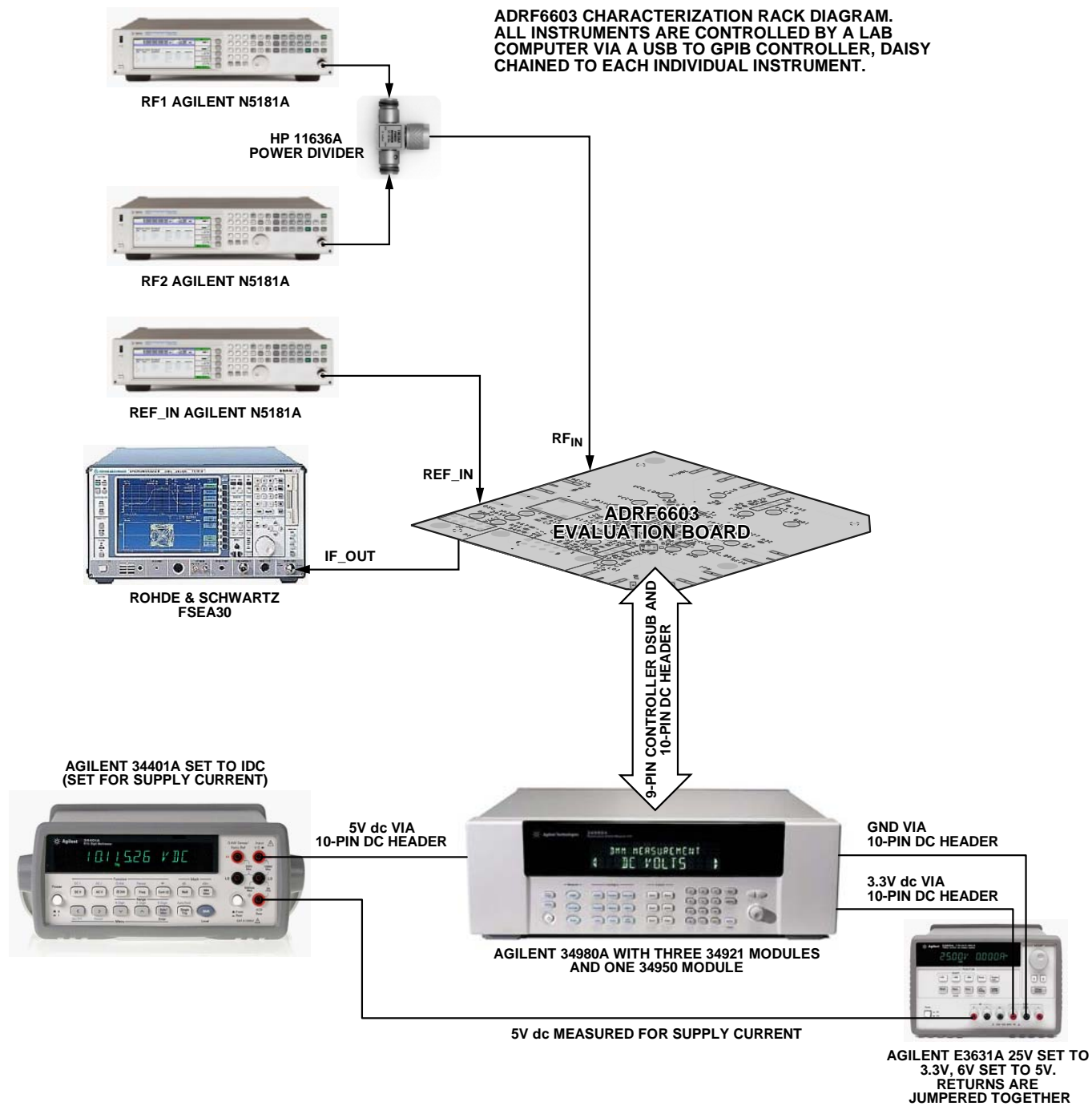

Figure 47. ADRF6603 AC Test Setup

08547-047

ADRF6603

EVALUATION BOARD

Figure 50 shows the schematic of the RoHS-compliant evaluation board for the ADRF6603. This board has four layers and was designed using Rogers 4350 hybrid material to minimize high frequency losses. FR4 material is also adequate if the design can accept the slightly higher trace loss of this material.

The evaluation board is designed to operate using the internal VCO of the device (the default configuration) or with an external VCO. To use an external VCO, R62 and R12 should be removed. Place 0 Ω resistors in R63 and R11. The input of the external VCO should be connected to the VTUNE SMA connector, and the external VCO output should be connected to the LO IN/OUT SMA connector. In addition to these hardware changes, internal register settings must also be changed to enable operation with an external VCO (see the Register 6—VCO Control and VCO Enable (Default: 0x1E2106) section).

Additional configuration options for the evaluation board are described in Table 10.

EVALUATION BOARD CONTROL SOFTWARE

Software to program the ADRF6603 is available for download on the [ADRF6603](#) product page under the Evaluation Boards & Development Kits section. To install the software

1. Download and extract the zip file:
ADRF6x0x_3p0p0_XP_install.exe file.
2. Follow the instructions in the read me file.

The evaluation board can be connected to the PC using a PC parallel port or a USB port. These options are selectable from the opening menu of the software interface (see Figure 48). The evaluation board is shipped with a 25-pin parallel port cable for connection to the PC parallel port.

To connect the evaluation board to a USB port, a USB adapter board ([EVAL-ADF4XXXZ-USB](#)) must be purchased from Analog Devices. This board connects to the PC using a standard USB cable with a USB mini-connector at one end. An additional 25-pin male to 9-pin female adapter is required to mate the ADF4XXXZ-USB board to the 9-pin D-Sub connector on the ADRF6603 evaluation board.

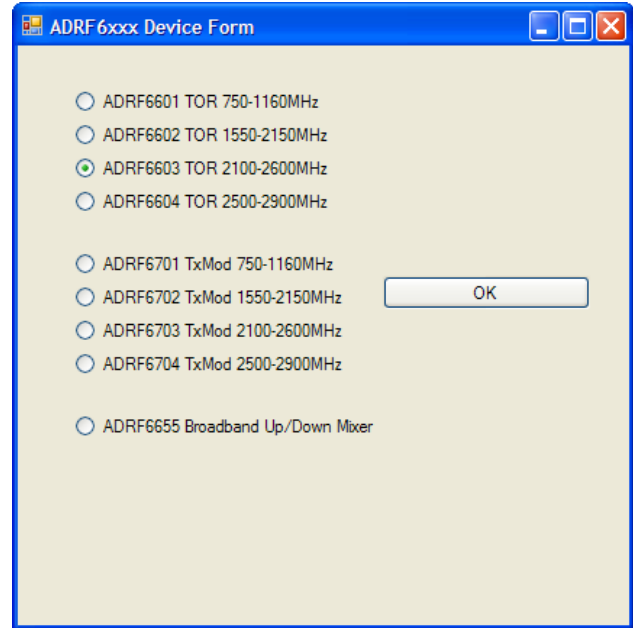

Figure 48. Control Software Opening Menu

Figure 49 shows the main menu of the control software with the default settings displayed.

Analog Devices ADRF6x0x Software - ADRF6603 TOR 2100-2600MHz

Device

LO Path and Modulator Control

LO Output Driver Disabled

Mixer LO Source - Internal VCO

PLL Enabled

RF Section

Divide Mode: Fractional

Ref Input Frequency: 38.4 MHz

PFD Frequency: 38.4 MHz

Modulus: 1536

VCO Frequency(2xLO): 2400 MHz

LO Frequency: 2400 MHz

Channel Step Size: 25 kHz

Charge Pump (CP)

Current Reference Source: Internal(250uA)

Current Multiplier: x2

CP Current (uA)= 500uA

Charge Pump Control: Hi-Z

CP Control Source: PFD

PFD Phase Offset Multiplier (0-31): 10 x 22.5°/CP current multiplier

PFD Phase Offset Polarity: positive

PFD Phase Offset: 112.5°

Output Reference Mux Source

Lock Detect

VCO Controls and Enables

VCO Enable: Enable

VCO LDO Enable: Enable

3.3V LDO Enable: Enable

Charge Pump Enable: Enable

External VCO Enable: Disable

VCO Switch Control from SPI: Regular

PFD

PFD Divider Path Edge Sensitivity: Falling Edge

PFD Reference Path Edge Sensitivity: Rising Edge

PFD Anti Backlash Delay: 0 nsec

Cap DAC Value: 0

Spare (R7) Value: 0

To be Loaded in Registers on Next Update

MSB	Binary				LSB	Hex
0000	0000	0000	0001	1111	0 000	000000
0000	0000	0011	0000	0000	0 001	000000
0000	0000	0001	1000	0000	0 010	000000
0110	0000	0000	0000	0000	1 011	000000

All Registers Updated

R0 Updated

R1 Updated

R2 Updated

R3 Updated

R4 Updated

R5 Updated

R6 Updated

R7 Updated

To be Loaded in Registers on Next Update

MSB	Binary				LSB	Hex
0000	1010	1010	0111	1010	0 100	000000
0000	0000	0000	0000	0110	0 101	000000
0001	1110	1101	1101	0000	0 110	000000
0000	0000	0000	0000	0000	0 111	000000

Figure 49. Main Screen of the ADRF6603 Evaluation Board Software

08547-049

SCHEMATIC AND ARTWORK

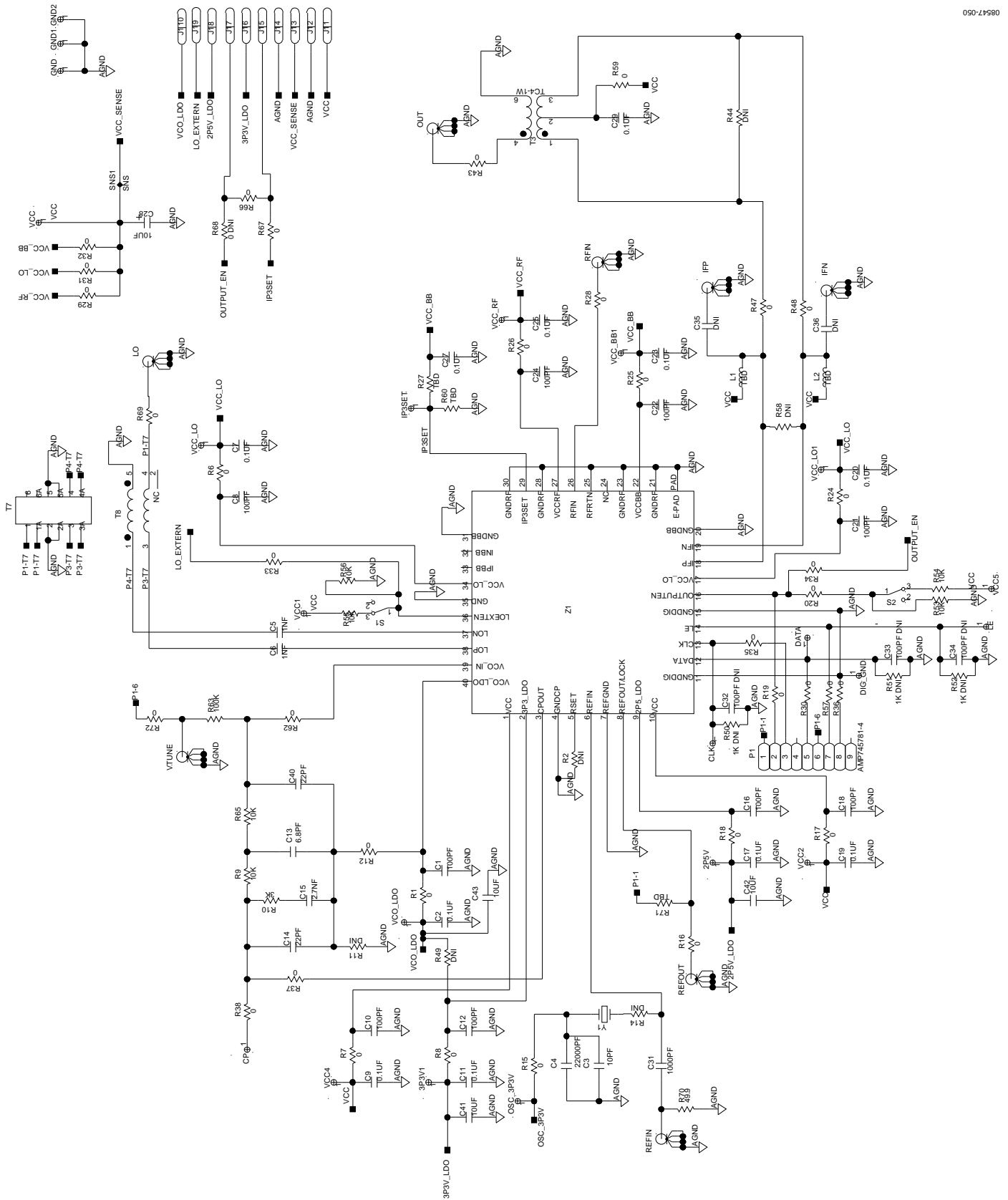

08547-050

Figure 50. Evaluation Board Schematic

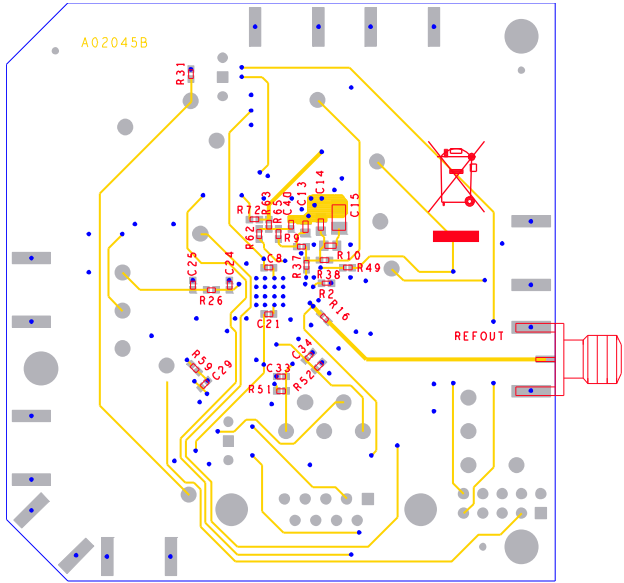

08547-013

Figure 51. Evaluation Board Layout (Bottom)

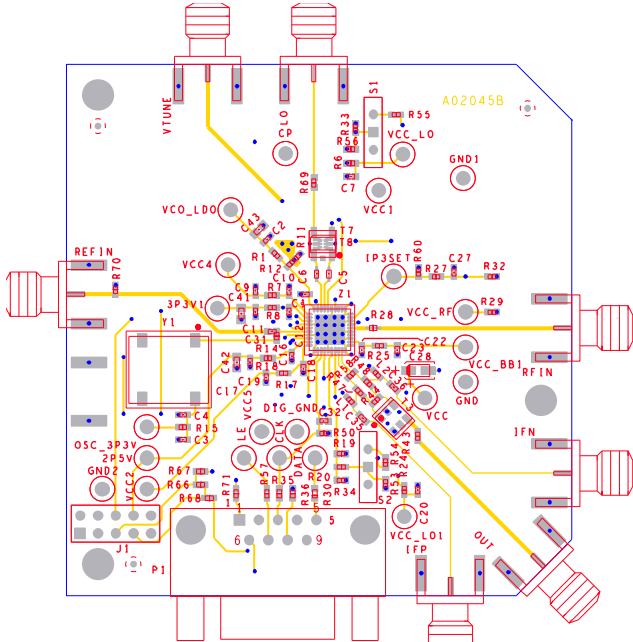

08547-012

Figure 52. Evaluation Board Layout (Top)

ADRF6603

EVALUATION BOARD CONFIGURATION OPTIONS

Table 10.

Component	Description	Default Condition/ Option Settings
S1, R55, R56, R33	LO select. Switch and resistors to ground the LODRV_EN pin. The LODRV_EN pin setting, in combination with internal register settings, determines whether the LOP and LON pins function as inputs or outputs (see the LO Selection Logic section for more information).	S1 = R55 = open (not installed), R56 = R33 = 0 Ω , LODRV_EN = 0 V
LO IN/OUT SMA Connector	LO input/output. An external 1 \times LO or 2 \times LO can be applied to this single-ended input connector.	LO input
REFIN SMA Connector	Reference input. The input reference frequency for the PLL is applied to this connector. Input impedance is 50 Ω .	
REFOUT SMA Connector	Multiplexer output. The REFOUT connector connects directly to the MUXOUT pin. The on-board multiplexer can be programmed to bring out the following signals: REFIN, 2 \times REFIN, REFIN/2, and REFIN/4; temperature sensor output voltage; and lock detect indicator.	Lock detect
CP Test Point	Charge pump test point. The unfiltered charge pump signal can be probed at this test point. Note that the CP pin should not be probed during critical measurements such as phase noise.	
R37, C14, R9, R10, C15, C13, R65, C40	Loop filter. Loop filter components.	
R11, R12	Loop filter return. When the internal VCO is used, the loop filter components should be returned to Pin 40 (DECLVCO) by installing a 0 Ω resistor in R12. When an external VCO is used, the loop filter components can be returned to ground by installing a 0 Ω resistor in R11.	R12 = 0 Ω (0402), R11 = open (0402)
R62, R63, VTUNE SMA Connector	Internal vs. external VCO. When the internal VCO is enabled, the loop filter components are connected directly to the VTUNE pin (Pin 39) by installing a 0 Ω resistor in R62. To use an external VCO, R62 should be left open. A 0 Ω resistor should be installed in R63, and the voltage input of the VCO should be connected to the VTUNE SMA connector. The output of the VCO is brought back into the PLL via the LO IN/OUT SMA connector.	R62 = 0 Ω (0402), R63 = open (0402)
R2	R _{SET} pin. This pin is unused and should be left open.	R2 = open (0402)
RFIN SMA Connector	RF input. The RF input signal should be applied to the RFIN SMA connector. The RF input of the ADRF6603 is ac-coupled, so no bias is necessary.	R3 = R23 = open (0402)
T3	IF output. The differential IF output signals from the ADRF6603 (IFP and IFN) are converted to a single-ended signal by T3.	

OUTLINE DIMENSIONS

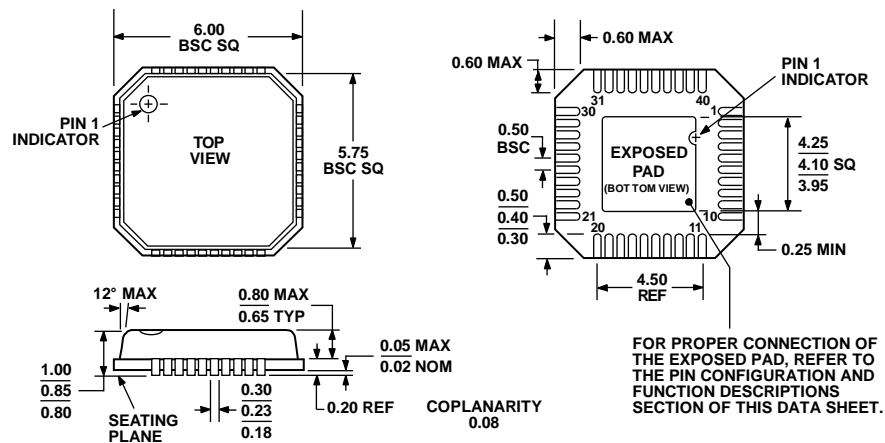

COMPLIANT TO JEDEC STANDARDS MO-220-VJJD-2

Figure 53. 40-Lead Lead Frame Chip Scale Package [LFCSP_VQ]
 6 mm × 6 mm Body, Very Thin Quad
 (CP-40-1)
 Dimensions shown in millimeters

072108-A

ORDERING GUIDE

Model ¹	Temperature Range	Package Description	Package Option
ADRF6603ACPZ-R7	-40°C to +85°C	40-Lead Lead Frame Chip Scale Package [LFCSP_VQ]	CP-40-1
ADRF6603-EVALZ		Evaluation Board	

¹ Z = RoHS Compliant Part.

ADRF6603

NOTES

NOTES

ADRF6603

NOTES